



+



+



+



Product Contents

+



+

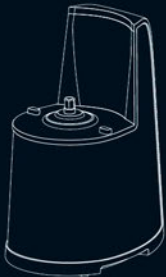

HG SERIES MANUAL

HUROM®

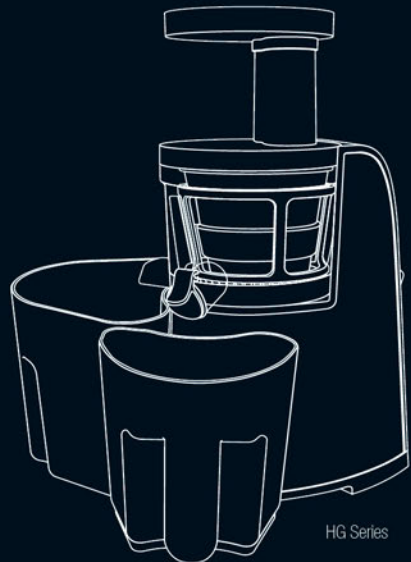

HG Series

Hurom Juicer Manual For Household Use (Warranty Included)

- 1 Read "Precautions for safe use (Page 4)" carefully and use the appliance properly.
- 2 Keep the manual within reach anytime and save it for future reference.
- 3 Check if the voltage indicated on the base of the appliance corresponds to the local voltage before you connect the appliance.
- 4 Any quality improvements are subject to change without notice.

CONTENTS

Dear Hurom Customers	01
General description and parts names	02
Specific terms for parts	03
Precautions for safe use	04
Warnings and cautions	05
Slow Juicer assembly	08
Slow Juicer assembly in detail	09
How to use the appliance	10
Juice Cap and Extraction Packing	11
When the Screw is stopped during operation (How to use [Reverse/REV] button)	12
Important safeguards in use	13
Disassembly, cleaning and care	14
Bowl disassembly and wash	16
Sterilization and Easy Cleaning System	17
Spinning Brush disassembly and wash	18
Spinning Brush assembly	19
Bowl Packing assembly	20
Juice Cap Packing assembly	21
Troubleshooting	22
Appliance specifications	23
Warranty	24

HUROM

With Hurom's own Slow Squeezing System and the Juice Cap as an additional mixing function, you can easily make personalized juice in rich tastes and flavors in full preserved valuable nutrients.

1. Much More Nutrients and Taste: Your own personalized juice

Various mixed juice

Not only enjoying single fruit juice but also adding various ingredients to your taste and health, you can simply make your own HUROM juice.

Hurom juice as an alternative meal

Make Hurom juice as an alternative meal in rich taste and balanced nutrients by mixing banana, corn or boiled potato, sweet potato and pumpkin, etc. supplementing calories with essential nutrients.

Hurom baby food

Mixing grain and vegetables with proper amount of water, you can easily make Hurom baby food for growth phases.

Soybean milk and soy juice

Unlike the traditional method that you must put boiled beans and water together, adjusting its portion while the Juice Cap is closed, anyone can easily make soybean milk and soy juice in desired concentration.

2. Much More Convenient and User Friendly

Opening and closing the juice cap, you can adjust the amount of juice as desired without any drops when you pour juice into a container.

3. Much More Advanced Easy Cleaning System (Page 17)

Unlike the method rinsing under tap, it is easier and simpler with the Juice Cap. Just fill up the bowl with water while the Juice Cap is closed and then operate the appliance for easy washing.

GENERAL DESCRIPTION AND PARTS NAMES

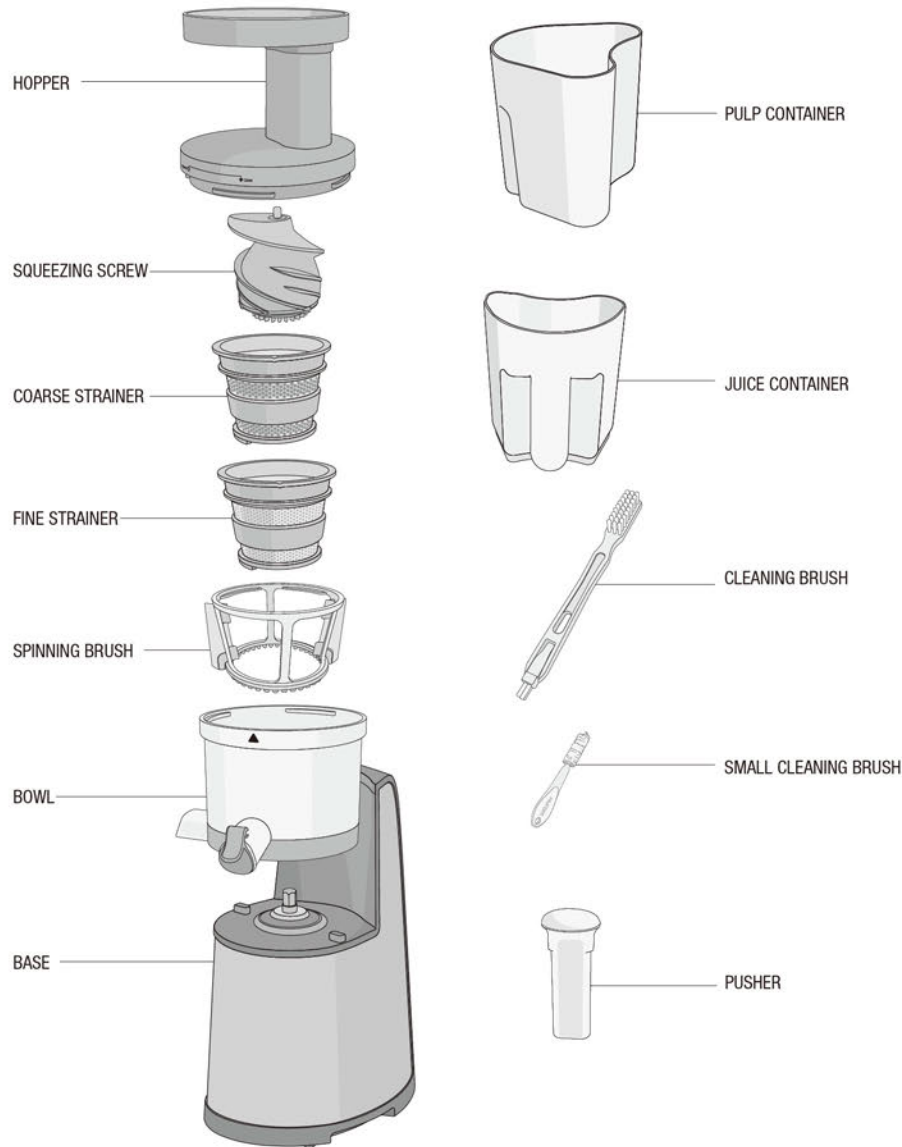

SPECIFIC TERMS FOR PARTS

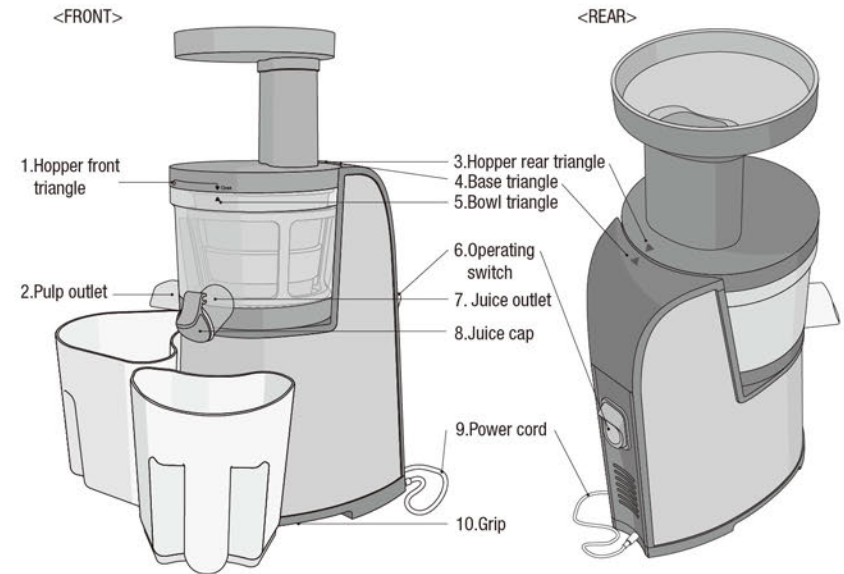

STRAINER*



COARSE STRAINER

The bigger hole of the strainer produce thicker juice when tender and soft fruits are extracted such as strawberries, kiwis and tomatoes. It is useful to extract more pulpy juice.

FINE STRAINER

The holes of the strainer are small. Use it when making pure juice with hard fruits, beans or higher fibered vegetables. It is useful to extract clearer juice.

NUMBER OF ATTACHMENT 1 pusher, 1 hopper, 1 screw, 1 fine strainer, 1 coarse strainer, 1 spinning brush, 1 bowl, 1 base, 1 juice container, 1 pulp container, 1 small cleaning brush, 1 cleaning brush, 1 manual

PRECAUTIONS FOR SAFE USE

All users of this appliance must read and understand this safety precaution before operating.



WARNING Hazards or unsafe practices which could result in serious personal injury or death.

CAUTION Hazards or unsafe practices which could result in minor personal injury or appliance damage.

SIGN EXAMPLES



This sign indicates contents that may cause risk of a fire or an electrical shock. Specific warnings are written in the sign.



This sign indicates contents that may cause risk of a fire or an electrical shock. Specific warning is written in the sign.



This sign indicates prohibited acts. Specific prohibitions are written around or in the sign.



This sign indicates contents of regulating or directing actions. Specific instructions are written around or in the sign.

WARNINGS AND CAUTIONS



WARNING Hazards or unsafe practices which could result in serious personal injury or death.



DO NOT PLUG IN OR UNPLUG WITH WET HANDS.

It may cause an electric shock or an injury.



DO NOT USE OTHER THAN 230V - 240V AC.

It may cause an electric shock, a fire or an abnormal performance. If the voltage is different, it may shorten the life of the motor or cause a failure.



PLUG THE POWER CORD CORRECTLY AND PUSH IT TIGHT IN A WALL SOCKET.

It may cause an electric shock or a fire.



IF THE SUPPLY CORD IS DAMAGED, IT MUST BE REPLACED BY THE MANUFACTURER, ITS SERVICE OR SIMILARLY QUALIFIED PERSONS IN ORDER TO AVOID A HAZARD.

If the power cord is damaged, it may cause an electric shock or a fire.



NEVER ALTER THE APPLIANCE. ALSO, DO NOT DISASSEMBLE OR REPAIR BY YOURSELF. DO NOT INSERT FINGERS, FOREIGN SUBSTANCES OR OBJECTS SUCH AS PINS INTO GAPS OR HOLES IN THE BASE. It may cause a fire, an electric shock or a failure.

For any technical support, contact the authorized local Customer Care Center.



DO NOT MOISTEN THE BASE OR SPLASH WATER ON THE BASE.

Be careful not to let any liquids or other substances get into the switch on the appliance.

DO NOT OPERATE THE SWITCH WITH WET HANDS.

It may cause an electric shock or a fire.

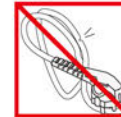

WHEN THE POWER CORD, WIRE WAS BROKEN OR DAMAGED OR THE PLUG-IN PART BECAME LOOSE, DO NOT OPERATE IT.

It may cause an electric shock, a fire or an injury.



FOR SAFETY, MUST DO GROUNDING CONNECTION. ALSO, DO NOT DO THE GROUNDING ON GAS PIPE, PLASTIC WATER PIPE, TELEPHONE WIRE, ETC.

It could cause an electric shock, a fire, a malfunction and an explosion.

Be sure to use the socket with ground connection.

WARNINGS AND CAUTIONS



NEVER DISASSEMBLE BOWL SET DURING OPERATION OR INSERT FINGERS, FOREIGN OBJECTS SUCH AS FORKS, SPOONS ETC. INTO FEEDING TUBE OR JUICE OUTLET. It may cause an injury, an accident or a failure.



THIS APPLIANCE IS NOT INTENDED FOR USE BY PERSONS (INCLUDING CHILDREN) WITH REDUCED PHYSICAL, SENSORY OR MENTAL CAPABILITIES, OR LACK OF EXPERIENCE AND KNOWLEDGE, UNLESS THEY HAVE BEEN GIVEN SUPERVISION OR INSTRUCTION CONCERNING USE OF THE APPLIANCE BY A PERSON RESPONSIBLE FOR THEIR SAFETY. Children should be supervised to ensure that they do not play with the appliance.



CAUTION Hazards or unsafe practices which could result in minor personal injury or appliance damage.



DO NOT OPERATE WITHOUT LOCKING THE HOPPER PROPERLY. It may cause an injury or a failure.



WHEN DETECTING A GAS LEAK, DO NOT INSERT THE POWER CORD INTO ITS SLOT. OPEN THE WINDOW TO VENTILATE FULLY AND IMMEDIATELY. It may cause an injury or a failure.



NEVER PUT A FINGER, A FORK OR A SPOON, ETC. INTO JUICE OUTLET. It may cause an injury or a failure.



IF SCREW ROTATION IS STOPPED IN NORMAL OPERATION, PRESS [REVERSE/REV] BUTTON AND HOLD FOR 2~3 SECONDS AND THEN AFTER REVERSE OPERATION IS COMPLETELY STOPPED, PRESS [ON] BUTTON AGAIN. If such a stop event continues during the operation, the parts may be damaged and performance may be deteriorated due to overheating in a motor. When the problem continues, immediately stop the appliance and contact the local Customer Care Center.



DURING THE OPERATION, DO NOT ATTEMPT TO MOVE THE BASE, DISASSEMBLE THE BOWL SET OR PARTS AND TRY TO LOCK THEM. It may cause an injury or a failure. Any act of event needed, switch off first and unplug the power cord.

WARNINGS AND CAUTIONS

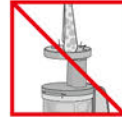

WHEN USING THE APPLIANCE, BE CAREFUL FOR A NECKTIE, LONG NECKLACE, SCARF, ETC. NOT TO BE ENTANGLED INTO FEEDING TUBE. It may cause an injury, a failure or a breakage.



PLACE THE APPLIANCE ON A FLAT AND STABLE SURFACE. It may cause an injury or a failure.



DO NOT OPERATE THE APPLIANCE FOR MORE THAN 30 MINUTES AT A TIME. It may cause a motor failure due to overheating. Cool it down sufficiently about 5 minutes and operate it again.



WHEN PLACING INGREDIENTS INTO THE FEEDING TUBE, ONLY USE THE PUSHER PROVIDED. It may cause an injury or a failure.



DO NOT ALLOW A SEVERE SHOCK TO THE APPLIANCE OR DROP IT. It may cause an electric shock, a fire or damage.



IF THE APPLIANCE GIVES OFF AN UNPLEASANT SMELL OR EXCESSIVE HEATING, SMOKE, STOP USING IMMEDIATELY AND CONTACT THE LOCAL CUSTOMER CARE CENTER. When using a new appliance, it gives off a smell and the smell disappears naturally over time.



ALWAYS UNPLUG THE APPLIANCE AFTER USE. WHEN UNPLUGGING THE POWER CORD, MAKE SURE TO HOLD THE POWER CORD. If holding the wire to unplug, it may cause an electric shock or a fire.



DO NOT WASH AT HIGH TEMPERATURES OF 80°C(176°F) OR MORE. DO NOT PUT THE APPLIANCE IN A DISHWASHER, A DRYER OR A MICROWAVE ETC. It may cause a failure or parts deformation.



THE APPLIANCE WEIGHS ABOUT 5.4KG (11.9LB). WHEN MOVING THE APPLIANCE, ENSURE TO MOVE IT HOLDING GRIPS TIGHTLY AT THE BASE BOTTOM WITH BOTH HANDS. If attempting to hold bowl or the edge of the base, the base falls causing an injury or a failure.

SLOW JUICER ASSEMBLY

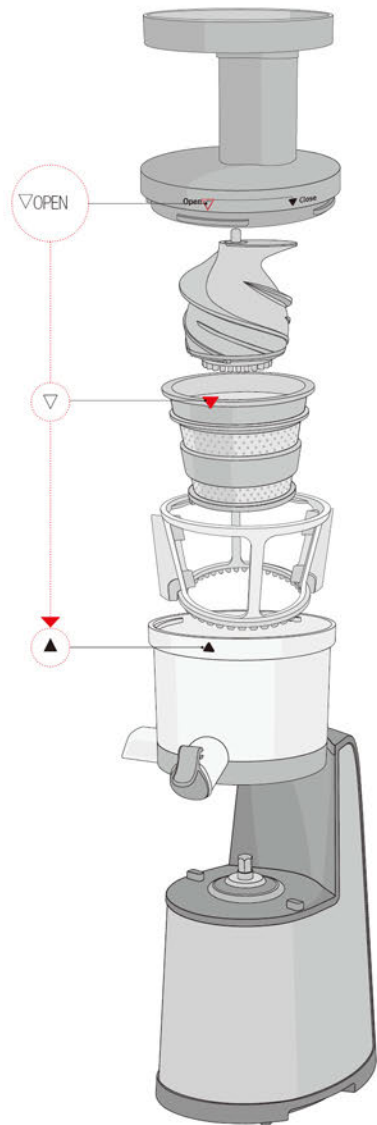

STEP 4 Align the bowl triangle [▲] with hopper triangle [▽ OPEN] and turn the hopper clockwise until it clicks so that the hopper triangle [▽ CLOSE] aligned with bowl triangle [▲].

STEP 3 Make sure to press the screw down into the strainer in STEP 2. The hopper does not close properly when the screw does not fit in completely.

STEP 2 Assemble the parts in the following order: Bowl>Spinning Brush> Strainer. Make sure bowl triangle [▲] aligns with strainer triangle [▽].
▶ A spinning brush can be assembled regardless of the direction.

STEP 1 Place the bowl in the base.

SLOW JUICER ASSEMBLY IN DETAIL

4 Align the base triangle with the hopper triangle at the rear of the appliance completely. The hopper does not close properly when the parts are not assembled correctly.

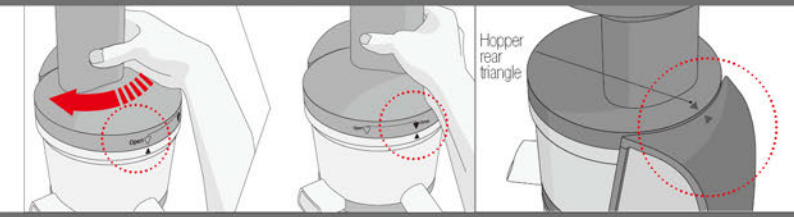

2,3 Assemble the parts in the order of bowl> spinning brush> strainer> squeezing screw> hopper (or assemble the spinning brush into the bowl then fit strainer bump in the bowl inner groove). Make sure all the triangles of bowl [▲], strainer [▽] and hopper [▽ OPEN] are aligned in a vertical line.

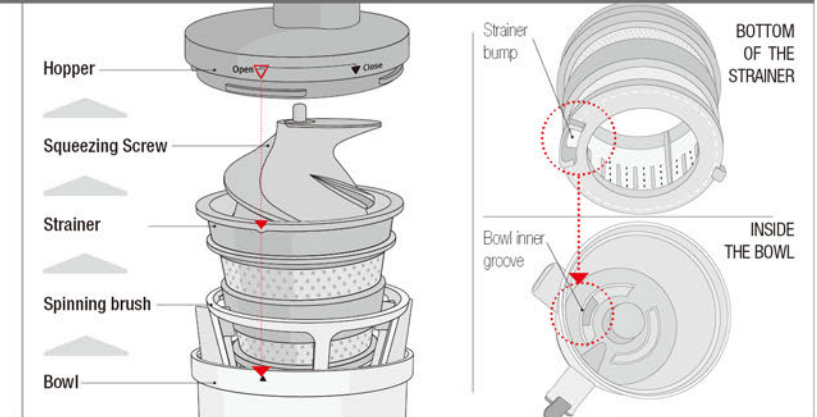

1 Insert extraction packing at the bottom of the bowl hard enough into the pulp outlet. Make sure bowl outer groove aligns with base bump completely.

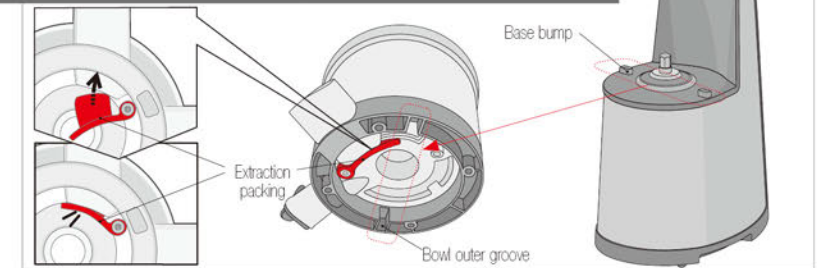

HOW TO USE THE APPLIANCE

REAR VIEW

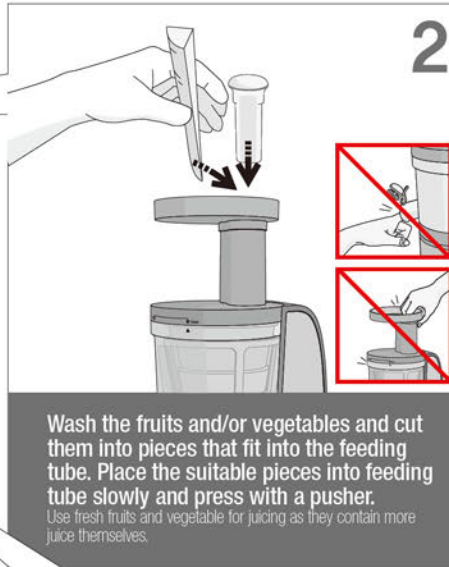
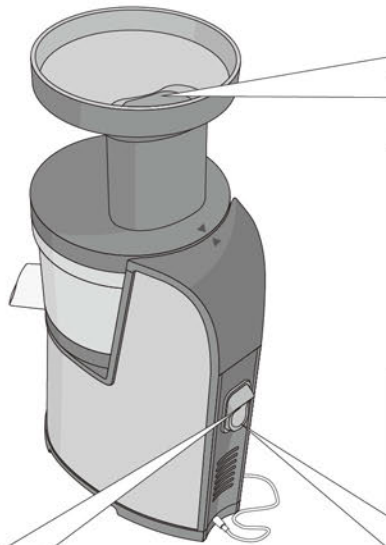

Wash the fruits and/or vegetables and cut them into pieces that fit into the feeding tube. Place the suitable pieces into feeding tube slowly and press with a pusher. Use fresh fruits and vegetable for juicing as they contain more juice themselves.

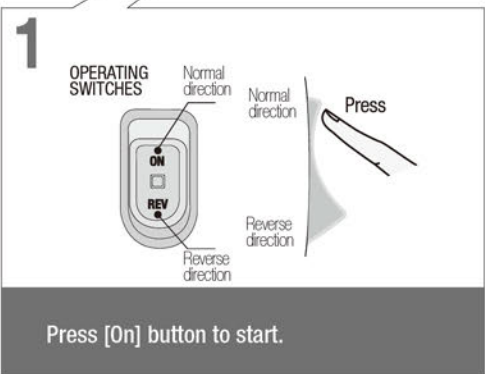

Press [On] button to start.

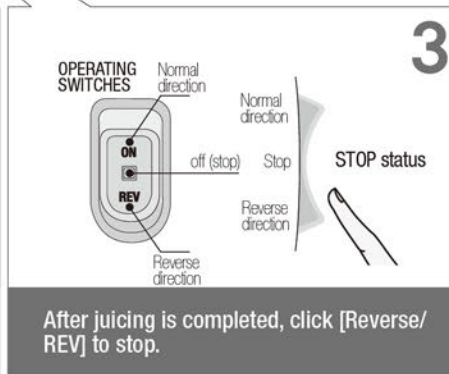

After juicing is completed, click [Reverse/REV] to stop.

► Motor does not stop immediately clicking [Reverse/REV] for the safety reason and performance. It stops slowly.

JUICE CAP AND EXTRACTION PACKING

JUICE CAP

This is the cap of juice outlet in the bowl.

Close the juice cap and fill up with juice in the bowl with various ingredients. You can easily make mixed fruit juice or vegetable juice.



- 1** Close juice cap and press [ON] button to start.
- 2** When juice starts filling up the bowl, you can mix banana, nuts, boiled sweet potato, etc. and liquids such as milk, etc. as well as vegetables and fruits like smoothies.
- 3** Open juice cap to pour out as much as you need and close without any drops.

EXTRACTION PACKING

This is the pulp stopper made of silicone at the bottom of the bowl.

Make sure to close extraction packing always as shown below before use. For cleaning, let extraction packing opened and start washing. (Page 16)

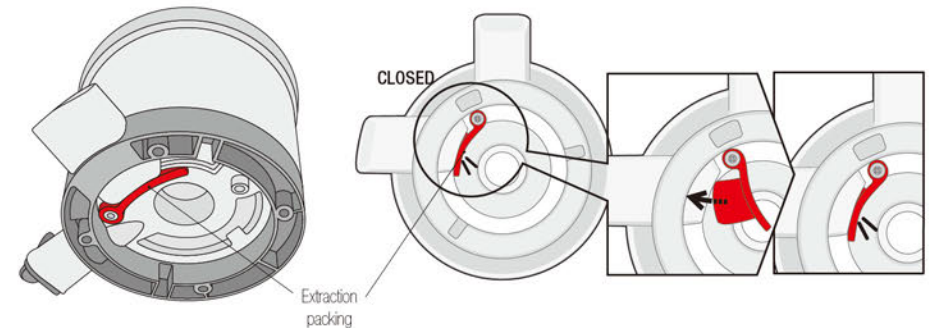

WHEN THE SCREW IS STOPPED DURING OPERATION (REVERSE/REV BUTTON)

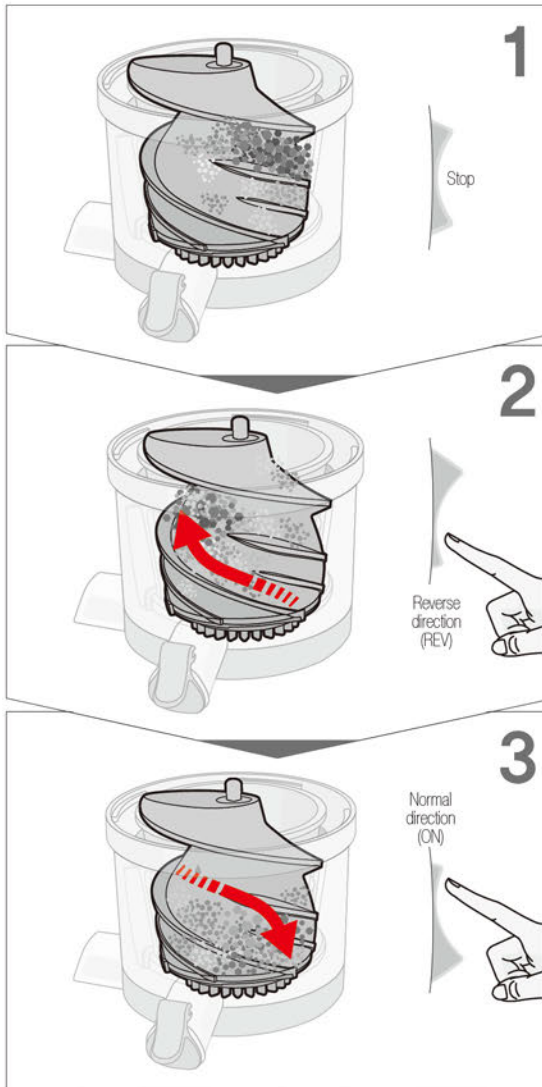

1 Click [Reverse/REV] button in operating switches and stop the appliance.

2 Press [Reverse/REV] button in operating switches for 3~5 seconds and release it. Repeat this process 2~3 times.

▶ Reverse is the button pushing ingredients upward. Reverse only works while the button is pressed and held. Once release the button, screw rotation stops.

3 After the rotation stops completely, press [ON] button to operate.

▶ Any direction you want to change from either Normal direction or Reverse direction, make sure that screw rotation is stopped completely. Then operate any button you need.

NOTE

If the screw does not work even after the above process, unplug the power cord from the socket, disassemble the bowl set, wash and use it again.

IMPORTANT SAFEGUARDS IN USE

- Fruits with pits, hard seeds such as nectarines, peaches, mangos, apricots, plums and cherries must be pitted before juicing.
- Cut fibrous ingredients (water parsleys, etc.) in small size like 3~4cm (1.5 inch) and place to the feeding tube.
- Drink the fruit juice or green vegetable juice immediately after you have extracted. If it is exposed to air sometime, the juice will lose its taste and natural value.
- Do not use the appliance for grinding the dry ingredients such as grains, coffee beans, etc. It may cause a part damaged or a failure.
- Do not squeeze the leftovers again which already come out from pulp outlet.
- Do not operate the appliance when the bowl is empty.



DO NOT USE IT FOR MORE THAN 30 MINUTES CONTINUOUSLY.

It may cause a failure due to overheating in a motor. But, when using continuously, stop and cool it down about 5 minutes for each use.

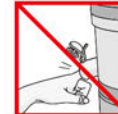

NEVER INSERT A FINGER, A FORK OR A SPOON, ETC. INTO JUICE OUTLET DURING OPERATION.

If inserting a fork, etc. into juice outlet during operation, it is stuck in spinning brush and causes a part damaged.



ONLY USE THE PUSHER TO PRESS DOWN THE INGREDIENTS.

Using other object, it is stuck in the screw and causes a part damaged, an injury or a failure.



DO NOT PLACE GRAINS, FRUIT WITH HARD SEED OR NUTS WITH HARD SHELL SUCH AS WALNUTS.

It may cause damage or a failure of bowl, screw, squeezing strainer, etc. Fruits with pits, hard seeds such as nectarines, peaches, mangos, apricots, plums and cherries must be pitted before juicing.



DO NOT OPERATE SWITCHES WITH WET HANDS.

It may cause an electric shock, an electric leakage or a fire. Do not stain any foreign substances around switches.



DO NOT PUT MEAT OR SEAFOOD.

It may cause abnormal performances or a failure.



DO NOT PUT FRUIT PRESERVED IN SUGAR, HONEY, ALCOHOL, ETC. (GRAPES, APRICOT, BERRIES, ETC.)

It may cause the hopper unopened.

NOTE

Frozen fruit or withered ingredients stored in the refrigerator for a long time may produce less juice or it is even hard to squeeze them.

DISASSEMBLY, CLEANING AND CARE

FIGURE IN ORDER

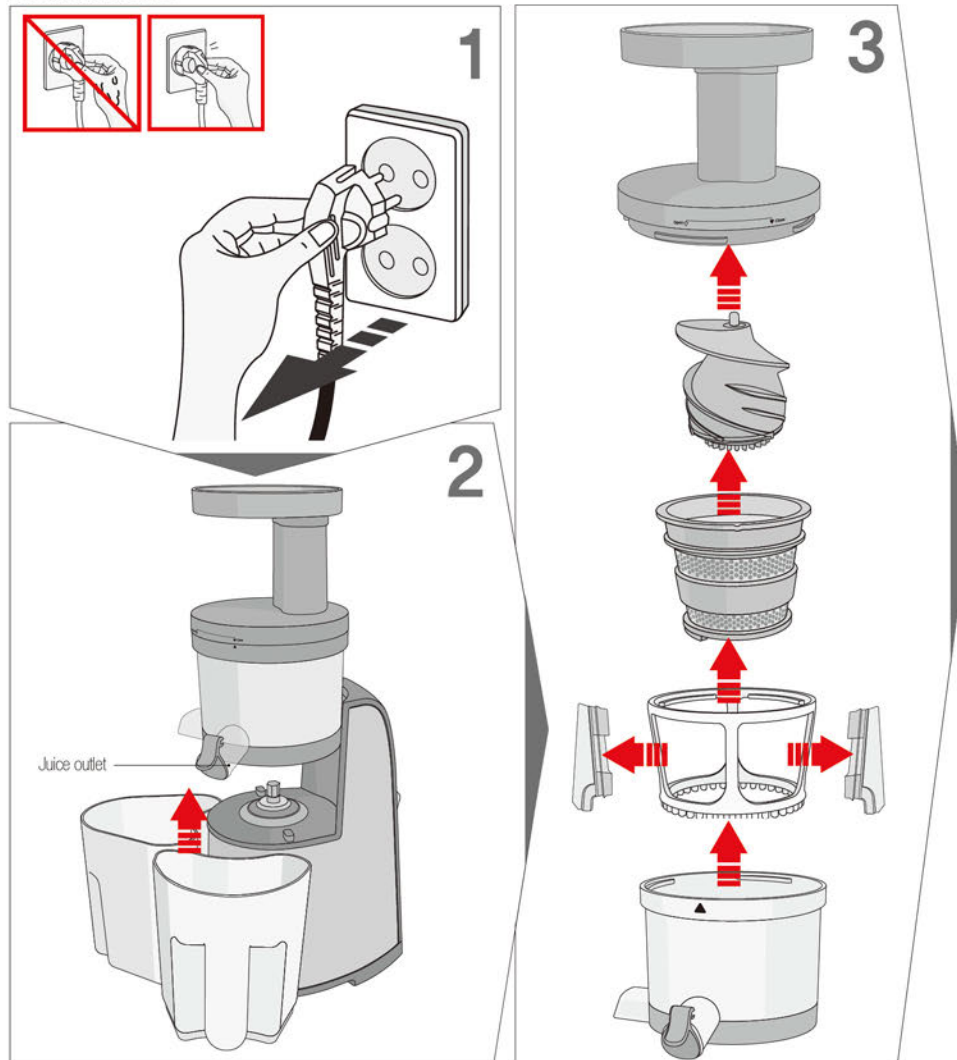

DISASSEMBLY, CLEANING AND CARE

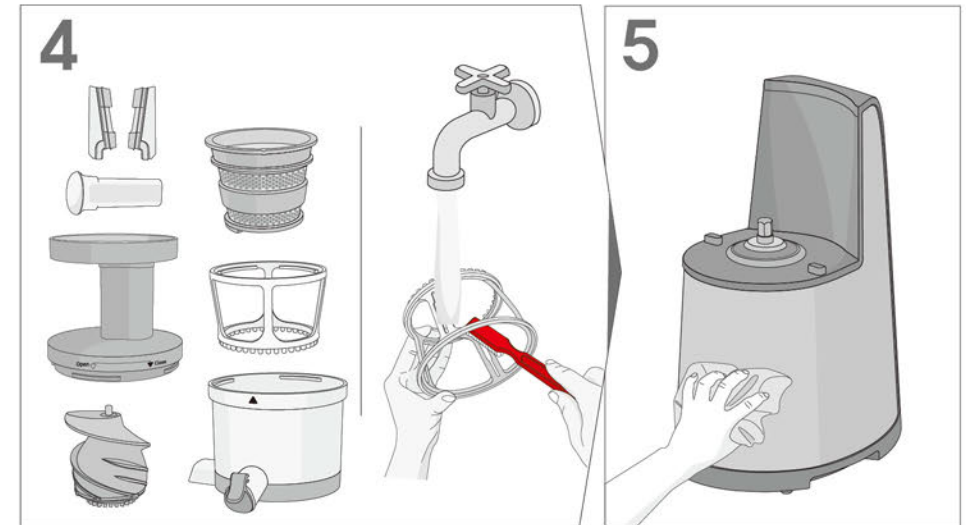

1. **Ensure the motor stops completely and unplug the power cord.**
 - ▶ When unplugging the power cord, hold the head part of the power cord and unplug it. Do not touch the power cord with wet hands.
2. **Hold the juice outlet and the hopper with both hands and lift them up from the base.**
3. **Disassemble the parts in reverse as below:**
 - 1) Unlock the bowl twisting to counterclockwise.
 - 2) Take the screw out.
 - 3) Remove the strainer.
 - 4) Take the spinning brush out and disassemble the silicone brush.
4. **Rinse each parts with cleaning brush and brush the inside and outside under running water.**
 - ▶ Never use scouring pads, abrasive cleaning agent, aggressive liquids or sharp cleaning tools. Do not wash them in a dishwasher or a dish dryer.
5. **Wipe the stain on the base with soft damp cloth or wrung towel and dry it thoroughly.**
 - ▶ Do not immerse the base unit in water or any other liquid, nor rinse it under tap.
6. **After each cleaning, allow them to air-dry completely and store them in a clean and safe place.**
 - ▶ Always wash the bowl set immediately after each use. Without wash-up, remained pulps get dried up and stuck onto it. It makes difficult to disassemble or wash them. Also, it may cause degradation in performance.

BOWL DISASSEMBLY AND WASH

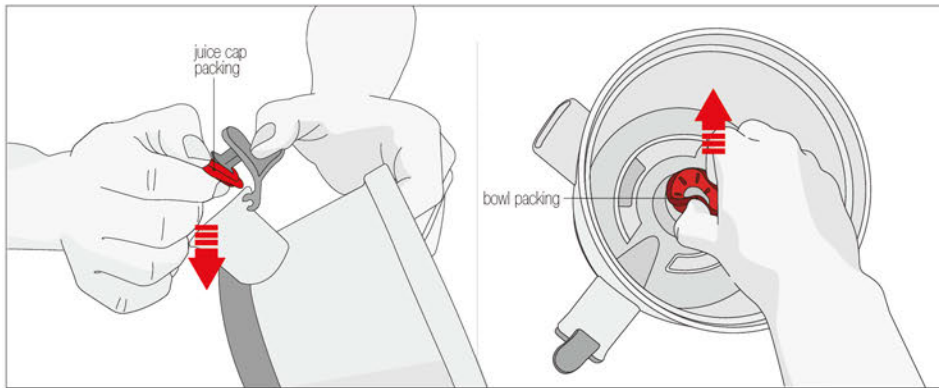

1 Remove Juice Cap packing and bowl packing.

- ▶ Open juice cap first. Hold the bowl and juice cap with one hand and remove juice cap packing with the other hand like taking it off. When removing it, be careful not to drop the juice cap and bowl. It may cause damage to the juice cap. Remove the bowl packing like pinching and twisting it with two fingers.

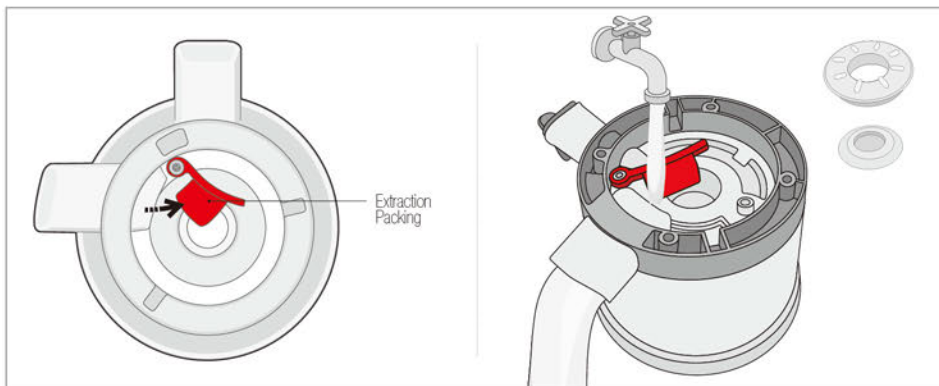

2 Open the extraction packing at the bottom of the bowl.

3 Wash the bowl and all the packings.

- ▶ Wash bowl and bowl packing with cleaning brush under the running water.

STERILIZATION AND EASY CLEANING SYSTEM

STERILIZATION

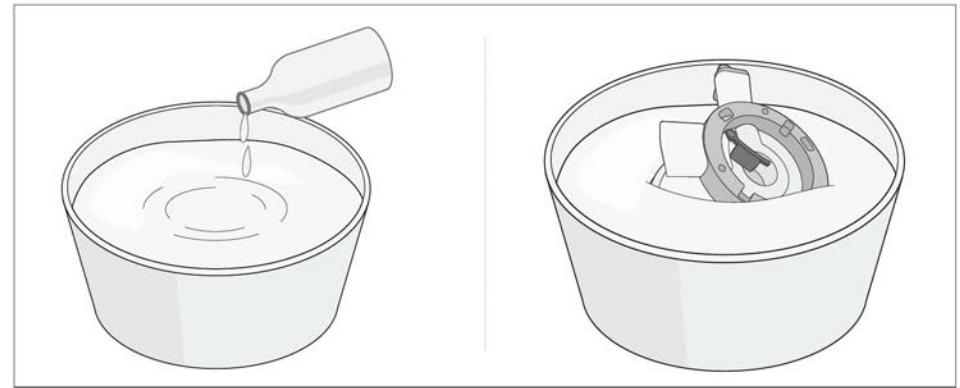

For sterilization, use baking soda or natural wash-up liquids only.

- ▶ You can thoroughly wash them immersing in the water diluted with one or two drops of baking soda or natural wash-up liquids for about 30 minutes.

EASY CLEANING SYSTEM

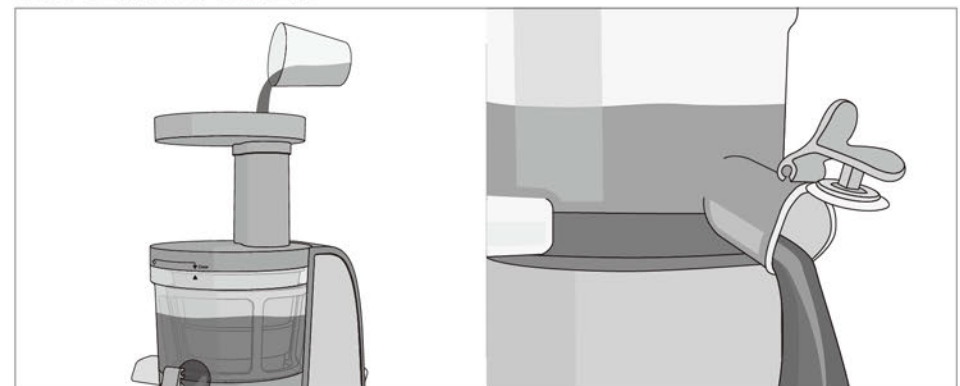

1 After closing the juice cap, pour the water into feeding tube and operate the appliance.

2 After a while, open the juice cap and discharge the water.

- ▶ Whenever changing the ingredient, it is not necessary to disassemble and wash the bowl. After juicing, make sure to disassemble and wash the bowl set.

SPINNING BRUSH DISASSEMBLY AND WASH

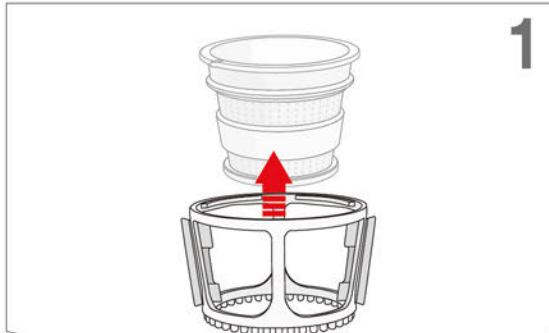

1

Remove the spinning brush from strainer.

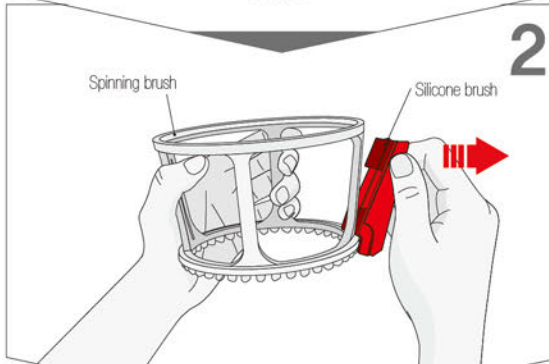

2

Detach the silicone brush from spinning brush.

- ▶ As shown to the left, hold the outer part of silicone brush with your fingers and pull it out to the arrow direction. It is recommendable to remove it according to the above method. If pulling it by force, silicone brush may be torn or spinning brush may be damaged.

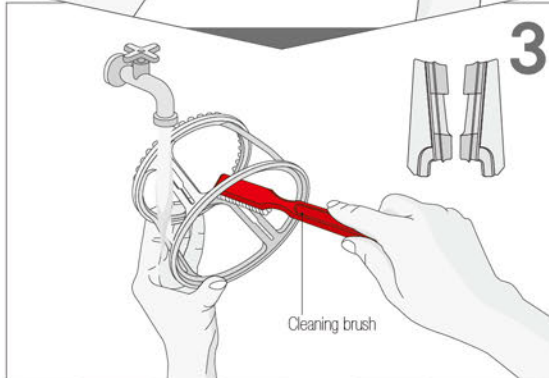

3

With cleaning brush, wash inside and outside of spinning brush like brushing under the running water.

- ▶ Wash silicone brush in the same way under the running water.

SPINNING BRUSH ASSEMBLY

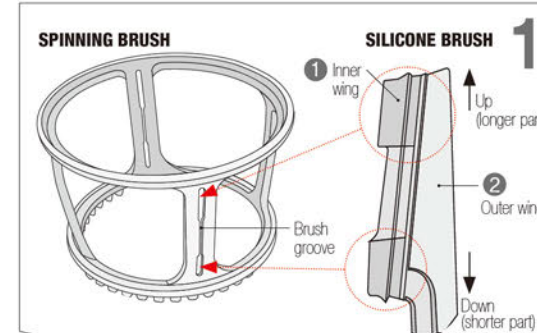

1

Check the groove of the spinning brush and the direction of silicone brush.

- ▶ There are grooves to insert silicone brush in the spinning brush. Silicone brush has inner wing **1** and outer wing **2**.
- ▶ As shown to the left, let 'inner wing' face the spinning brush.

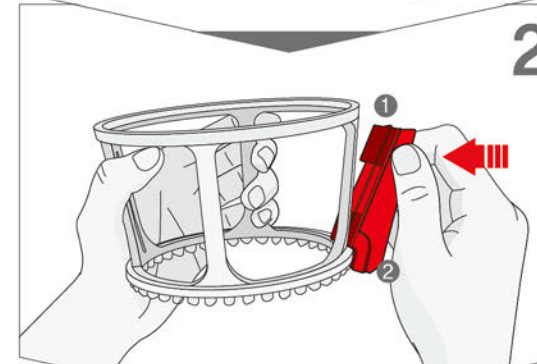

2

Insert the silicone brush into the spinning brush.

- ▶ According to the No. 1 above, let the longer part of inner wing **1** face upward.
- ▶ Hold the outer wing **2** of silicone brush with your thumb and index finger and insert the inner wing into the groove of spinning brush.

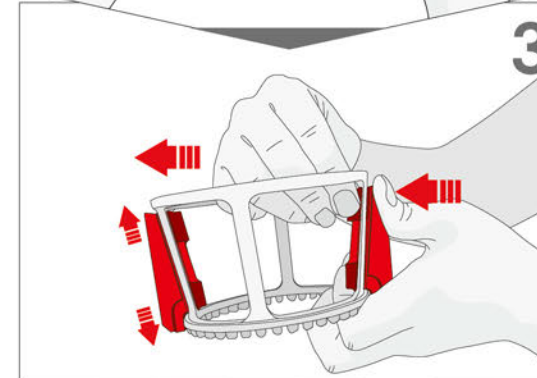

3

Pull the inner wing tight enough.

- ▶ Push silicone brush from the outer side of spinning brush and pull 'inner wing' in the direction of inside of the spinning brush with the other hand as shown to the left.
- ▶ Pull it until you cannot pull it any longer. If units are operating without fully assembled, there is a risk of breakage.
- ▶ Hold up and down of 'outer wing' and pull it tight enough.

BOWL PACKING ASSEMBLY

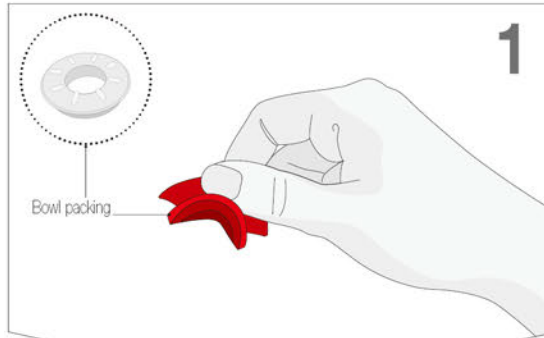

1

Hold the bowl packing like pinching.

- ▶ As shown to the left in a dotted circle, let the protrusion part on the bowl packing face upward and hold it like pinching with your thumb and index finger.

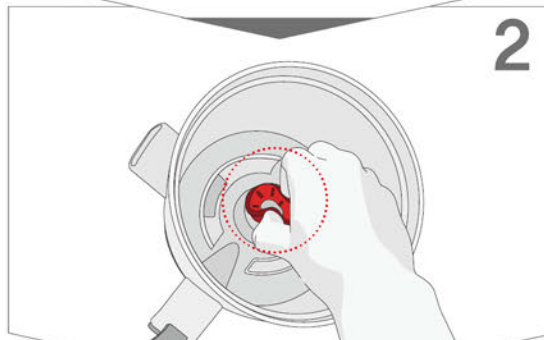

2

Insert the bowl packing into the bowl hole.

- ▶ Insert the bottom of the bowl packing into the bowl hole and fully press it down. Do not insert whole part of bowl packing. The upper part of the bowl packing must be shown.

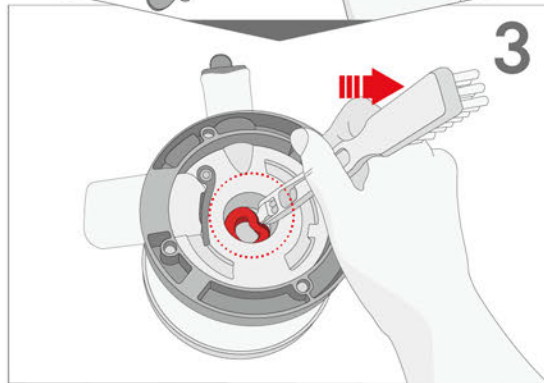

3

Turn over the bowl and organize the bowl packing in place.

- ▶ If the bowl packing at the bottom of the bowl is not fully inserted and bent, organize it with the rotating attractor of the cleaning brush.

JUICE CAP PACKING ASSEMBLY

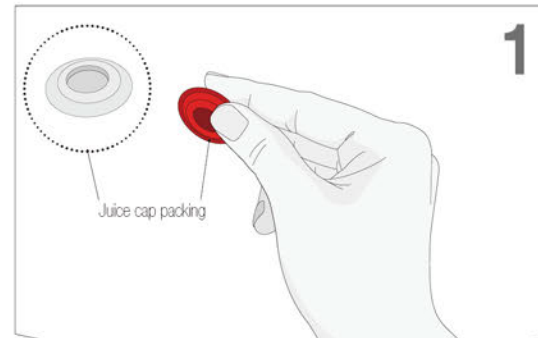

1

Hold juice cap packing as shown to the left.

- ▶ As shown to the left in a dotted circle, the hole must be visible when you hold.

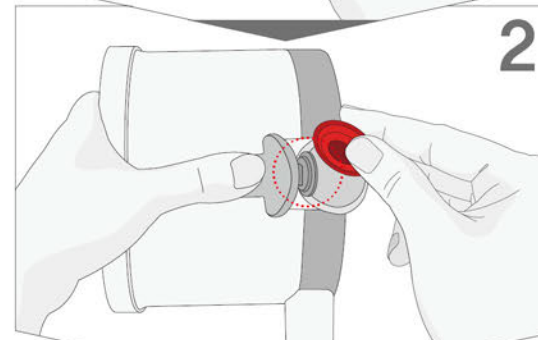

2

Open the juice cap and insert the juice cap packing in.

- ▶ Insert it in from the top to the juice cap. Be careful not to drop the bowl.

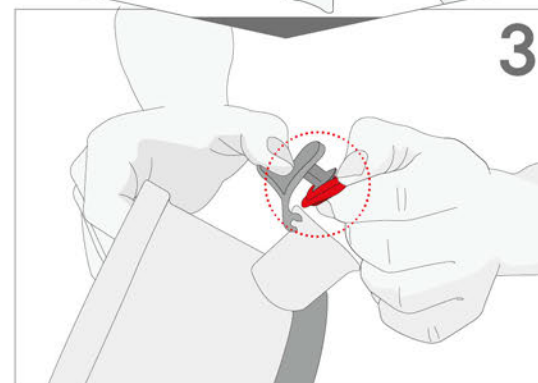

3

Organize the packing to seal off completely.

- ▶ If the packing is not completely sealed, it may cause juice leaking.

TROUBLESHOOTING

Check the details below before contacting Technical Support for repair or service.

If you need information or if you have a problem, please contact the local Customer Care Center or visit www.hurom.com.

When applying for after sales service, check the manufacturer's serial number or bar code.

THE APPLIANCE DOES NOT WORK.

Make sure the power cord is properly plugged in.

Check the hopper is assembled properly. If the hopper has not been properly locked in place, the appliance does not work for safety reason.

Check if the appliance has been assembled according to the manual in an ordinary manner.

See the assembly in the manual or consult with the local Customer Care Center for help.

THE HOPPER DOES NOT OPEN.

Are there lots of pulps left inside the bowl? Press [ON] button to discharge internal pulp somehow.

Have you placed any foreign substances or solid object such as hard seeds?

Press the [Reverse/REV] button to make foreign substances come up again toward the feeding tube.

Do not attempt to open it by force or with too much pressure. Still it does not work following by the above process, contact the local Customer Care Center.

IT STOPS DURING NORMAL OPERATION.

Have you put heavy loads of ingredient or thick/big ingredient? Read the manual Page 12 and follow Reverse/REV button guideline.

Still the problem has not been solved, contact the local Customer Care Center.

THERE ARE THE GATE MARKS (FORMING MARK) RESULTING FROM THE MOLDING PROCESS.

It is a normal part and there is no problem for use.

WHAT IS THE DIFFERENCE BETWEEN FINE STRAINER AND COARSE STRAINER?

Use fine strainer with 'small holes' if you want somewhat clear juice.

Use the coarse strainer with 'bigger holes' if you want more pulpy juice or thicker juice.

Regarding strainer selection for suitable ingredients, read the manual Page 3.

JUICE LEAKS OVER THE BASE.

Is Extraction packing properly inserted in?

Juice could leak when the extraction packing is not properly inserted in. Please push the extraction packing tight enough.

Juice is still leaking even though the extraction packing was inserted properly? Did you put heavy loads?

If an amount of input ingredient is too much compared to the size of pulp outlet, the packing may be slightly pushed out and juice may leak through the gap. Do not process heavy loads at a time and squeeze little by little.

THE BOWL SHAKES WHEN SQUEEZING.

Slight shaking may be occurred due to motor movement.

Large or small movements occur depending on the pulp texture of ingredients (hard or tough).

It is normal when the screw is rotating. Please note that it is not malfunction.

Hard ingredients (e.g: carrots/potatoes/radishes/beetroots, etc.) may shake the bowl more than soft and juicy ingredient.

APPLIANCE SPECIFICATIONS

APPLIANCE STANDARDS

PRODUCT NAME	Hurom Slow Juicer
MODEL NAME	HG Series
RATED VOLTAGE	230-240 V
RATED FREQUENCY	50 Hz
RATED POWER CONSUMPTION	150 W
RPM (REVOLUTIONS PER MINUTE)	42 rpm
CORD LENGTH	1.4 m
MOTOR	Single-phase induction motor
FUSE	250 V 5 A
WEIGHT	5.4 kg (11.9 lb)
OUTWARD DIMENSIONS	Width 160 mm Length 224 mm Height 418 mm
RATED OPERATING HOUR	Less than 30 minutes

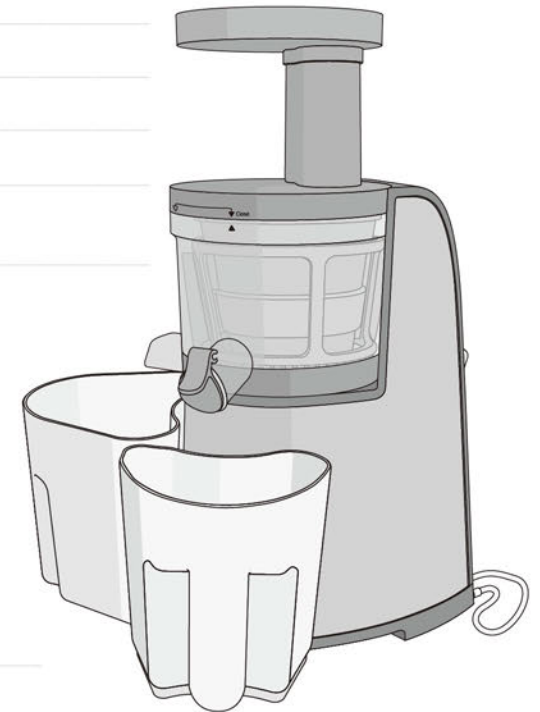

WARRANTY

Product name	_____	Model name	_____
Manufacture's serial number	_____	Date of purchase	_____
Supplier	_____	Customer name	_____
Address	_____		

Important: To better protect your purchase, fill out and mail this form to a local distributor where you have purchased, and keep the original receipt.

This certifies that the Hurom Slow Juicer is warranted by **HUROM** to be free from defects in material construction and workmanship.

The motor warranted for five (10) years and other parts are warranted for two (2) years from the date of purchase to the original purchaser. Coverage is valid only with proof of purchase from an Authorized Local Distributor. (No international warranty available)

This warranty does not apply to damages caused by accident, misuse, abuse, commercial use, alteration, failure to follow operating instructions, or damage caused by parts or service unauthorized by **HUROM**. Damages caused by transportation must be claimed with carrier.

HUROM disclaims all responsibilities for consequential damages from incidental losses caused by use of this appliance.

If service should be necessary, please contact our local Customer Care Center for technical difficulty.

HUROM Manufacture : **HUROM**
Hurom webpage : www.hurom.com

MEMO

HUROM®

1 4PJ12208 2 4PJ12204_V.04



www.hurom.com

Copyright© All Rights Reserved by HUROM